



Figure can vary

**Part no.: 68002924**  
**MLC520R90-2400**  
**Safety light curtain receiver**



## Contents

- Technical data
- Suitable transmitters
- Dimensioned drawings
- Electrical connection
- Circuit diagrams
- Operation and display
- Part number code
- Accessories
- Notes

## Technical data

<b>Basic data</b>	
Series	MLC 500
Device type	Receiver
Contains	2x BT-NC sliding block
Application	Access guarding Danger zone guarding
<b>Functions</b>	
Function package	Standard
Functions	Transmission channel changeover Start/restart interlock (RES) Contactor monitoring (EDM)
<b>Characteristic parameters</b>	
Type	4, IEC/EN 61496
SIL	3, IEC 61508
SILCL	3, IEC/EN 62061
Performance Level (PL)	e, EN ISO 13849-1
PFH <sub>D</sub>	7.73E-09 per hour
Mission time T <sub>M</sub>	20 years, EN ISO 13849-1
Category	4, EN ISO 13849
<b>Protective field data</b>	
Resolution	90 mm
Protective field height	2,400 mm
<b>Optical data</b>	
Synchronization	Optical between transmitter and receiver
<b>Electrical data</b>	
Protective circuit	Overvoltage protection Short circuit protected
<b>Performance data</b>	
Supply voltage	24 V, DC, -20 ... 20 %
Current consumption, max.	150 mA
Fuse	2 A semi time-lag
<b>Inputs</b>	
Number of digital switching inputs	3 Piece(s)
<b>Switching inputs</b>	
Type	Digital switching input
Switching voltage high, min.	18 V
Switching voltage low, max.	2.5 V
Switching voltage, typ.	22.5 V
Voltage type	DC

**Outputs**

Number of safety-related switching outputs (OSSDs) 2 Piece(s)

**Safety-related switching outputs**

Type	Safety-related switching output OSSD
Switching voltage high, min.	18 V
Switching voltage low, max.	2.5 V
Switching voltage, typ.	22.5 V
Voltage type	DC
Current load, max.	380 mA
Load inductivity	2,000 $\mu$ H
Load capacity	0.3 $\mu$ F
Residual current, max.	0.2 mA
Residual current, typ.	0.002 mA
Voltage drop	1.5 V

**Safety-related switching output 1**

Assignment	Connection 1, pin 5
Switching element	Transistor, PNP

**Safety-related switching output 2**

Assignment	Connection 1, pin 6
Switching element	Transistor, PNP

**Timing**

Response time	8 ms
Restart delay time	100 ms

**Connection**

Number of connections 1 Piece(s)

**Connection 1**

Type of connection	Connector
Function	Machine interface
Thread size	M12
Material	Metal
No. of pins	8 -pin

**Cable properties**

Permissible conductor cross section, typ.	0.25 mm <sup>2</sup>
Length of connection cable, max.	100 m
Permissible cable resistance to load, max.	200 $\Omega$

**Mechanical data**

Dimension (W x H x L)	29 mm x 2,466 mm x 35.4 mm
Housing material	Metal, Aluminum
Lens cover material	Plastic / PMMA
Material of end caps	Diecast zinc
Net weight	2,550 g
Housing color	Yellow, RAL 1021
Type of fastening	Mounting bracket Groove mounting Swivel mount Mounting on Device Column

**Operation and display**

## Part no.: 68002924 – MLC520R90-2400 – Safety light curtain receiver

Type of display	7-segment display LED
Number of LEDs	2 Piece(s)

### Environmental data

Ambient temperature, operation	-30 ... 55 °C
Ambient temperature, storage	-30 ... 70 °C
Relative humidity (non-condensing)	0 ... 95 %

### Certifications

Degree of protection	IP 65
Protection class	III
Certifications	TÜV Süd c TÜV NRTL US c CSA US S Mark
Vibration resistance	50 m/s <sup>2</sup>
Shock resistance	100 m/s <sup>2</sup>
US patents	US 6,418,546 B

### Classification

eCl@ss 8.0	27272704
eCl@ss 9.0	27272704
ETIM 5.0	EC002549

## Suitable transmitters

	Part no.	Designation	Article	Description
	68000924	MLC500T90-2400	Safety light curtain transmitter	Resolution: 90 mm Protective field height: 2,400 mm Operating range: 0 ... 20 m Connection: Connector, M12, Metal, 5 -pin

## Dimensioned drawings

All dimensions in millimeters

Calculation of the effective protective field height  $H_{PFE} = H_{PFN} + B + C$

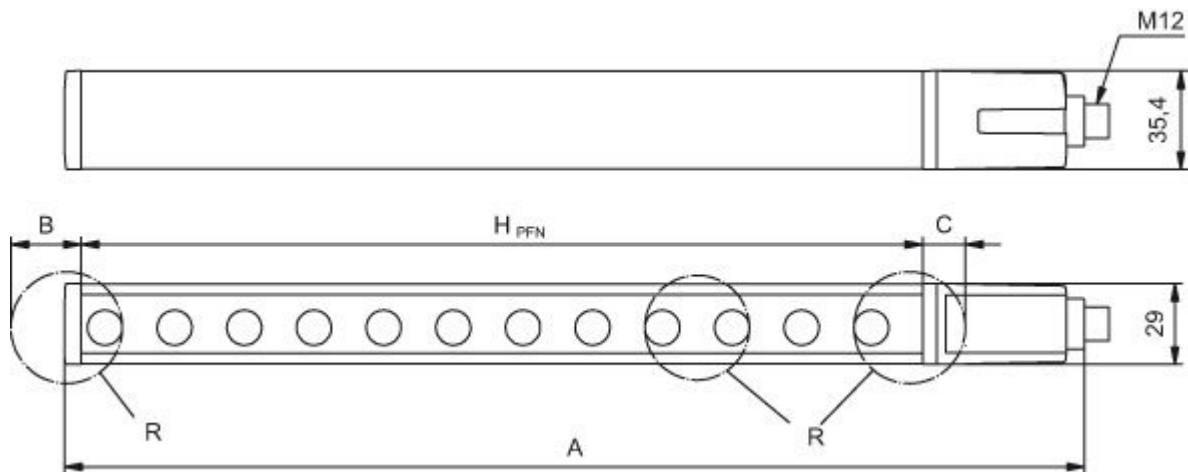

- HPFE Effective protective field height = 2490 mm
- HPFN Nominal protective field height = 2400 mm
- A Total height = 2466 mm
- B 50 mm
- C 40 mm
- R Effective protective field height  $H_{PFE}$  goes beyond the dimensions of the optics area to the outer borders of the circles labeled with R.

## Electrical connection

Connection 1	
Type of connection	Connector
Function	Machine interface
Thread size	M12
Type	Male
Material	Metal
No. of pins	8 -pin
Encoding	A-coded
Connector housing	FE/SHIELD

Pin	Pin assignment	Conductor color
1	IO1	White
2	VIN1	Brown
3	IN3	Green
4	IN4	Yellow
5	OSSD1	Gray
6	OSSD2	Pink
7	VIN2	Blue
8	IN8	Red

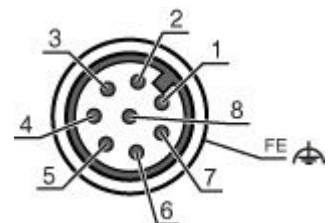

**Circuit diagrams**

Connection diagram receiver

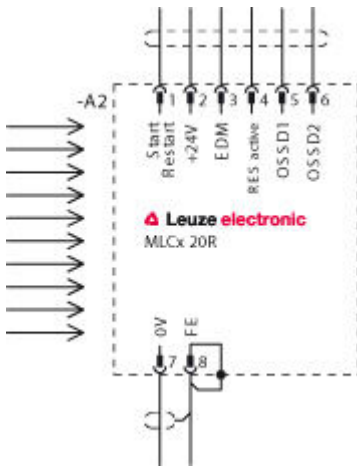

- VIN1 = +24 V, VIN2 = 0 V: transmission channel C1
- VIN1 = 0 V, VIN2 = +24 V: transmission channel C2

Circuit diagram example with downstream MSI-RM2 safety relay



**Operation and display**

LEDs

LED	Display	Meaning
1	Off	Device switched off

**Part no.: 68002924 – MLC520R90-2400 – Safety light curtain receiver**

LED	Display	Meaning
	Red, continuous light	OSSD off
	Red, flashing, 1 Hz	External error
	Red, flashing, 10 Hz	Internal error
	Green, flashing, 1 Hz	OSSD on, weak signal
	Green, continuous light	OSSD on
2	Off	RES deactivated or RES activated and enabled or RES blocked and protective field interrupted
	Yellow, continuous light	RES activated and blocked but ready to be unlocked - protective field free and linked sensor is enabled if applicable

## Part number code

Part designation: **MLCxyy-za-hhhhei-ooo**

MLC	Safety light curtain
x	<b>Series:</b> 3: MLC 300 5: MLC 500
yy	<b>Function classes:</b> 00: Transmitter 01: transmitter (AIDA) 02: Transmitter with test input 10: Basic receiver - automatic restart 11: basic receiver - automatic restart (AIDA) 20: Standard receiver - EDM/RES selectable 30: Extended receiver - blanking/muting
z	<b>Device type:</b> T: transmitter R: receiver
a	<b>Resolution:</b> 14: 14 mm 20: 20 mm 30: 30 mm 40: 40 mm 90: 90 mm
hhh	<b>Protective field height:</b> 150 ... 3000: from 150 mm to 3000 mm
e	<b>Host/Guest (optional):</b> H: Host MG: Middle Guest G: Guest
i	<b>Interface (optional):</b> /A: AS-i
ooo	<b>Option:</b> /V: high Vibration-proof EX2: explosion protection (zones 2 + 22) SPG: Smart Process Gating

### Note

A list with all available device types can be found on the Leuze electronic website at [www.leuze.com](http://www.leuze.com).

## Accessories

### Connection technology - Connection cables

	Part no.	Designation	Article	Description
 	429288	CB-M12-25000-8GF	Connection cable	Connection 1: Connector, M12, Axial, Female, A-coded, 8 -pin Connection 2: Open end Shielded: No Cable length: 25,000 mm Sheathing material: PUR
 	429289	CB-M12-50000-8GF	Connection cable	Connection 1: Connector, M12, Axial, Female, A-coded, 8 -pin Connection 2: Open end Shielded: No Cable length: 50,000 mm Sheathing material: PUR
 	50135128	KD S-M12-8A-P1-050	Connection cable	Connection 1: Connector, M12, Axial, Female, A-coded, 8 -pin Connection 2: Open end Shielded: Yes Cable length: 5,000 mm Sheathing material: PUR
 	50135129	KD S-M12-8A-P1-100	Connection cable	Connection 1: Connector, M12, Axial, Female, A-coded, 8 -pin Connection 2: Open end Shielded: Yes Cable length: 10,000 mm Sheathing material: PUR
 	50135130	KD S-M12-8A-P1-150	Connection cable	Connection 1: Connector, M12, Axial, Female, A-coded, 8 -pin Connection 2: Open end Shielded: Yes Cable length: 15,000 mm Sheathing material: PUR
 	50135131	KD S-M12-8A-P1-250	Connection cable	Connection 1: Connector, M12, Axial, Female, A-coded, 8 -pin Connection 2: Open end Shielded: Yes Cable length: 25,000 mm Sheathing material: PUR
 	50135132	KD S-M12-8A-P1-500	Connection cable	Connection 1: Connector, M12, Axial, Female, A-coded, 8 -pin Connection 2: Open end Shielded: Yes Cable length: 50,000 mm Sheathing material: PUR
 	50135122	KD U-M12-8A-P1-050	Connection cable	Connection 1: Connector, M12, Axial, Female, A-coded, 8 -pin Connection 2: Open end Shielded: No Cable length: 5,000 mm Sheathing material: PUR
 	50135123	KD U-M12-8A-P1-100	Connection cable	Connection 1: Connector, M12, Axial, Female, A-coded, 8 -pin Connection 2: Open end Shielded: No Cable length: 10,000 mm Sheathing material: PUR

**Part no.: 68002924 – MLC520R90-2400 – Safety light curtain receiver**

	Part no.	Designation	Article	Description
	50135124	KD U-M12-8A-P1-150	Connection cable	Connection 1: Connector, M12, Axial, Female, A-coded, 8 -pin Connection 2: Open end Shielded: No Cable length: 15,000 mm Sheathing material: PUR

**Connection technology - Connectors**

	Part no.	Designation	Article	Description
	429178	CB-M12-8GF	Connector	Connection: Connector, M12, Axial, Female, A-coded, 8 -pin

**Mounting technology - Mounting brackets**

	Part no.	Designation	Article	Description
	429056	BT-2L	Mounting bracket set	Design of mounting device: Angle, L-shape Mounting bracket, at system: Through-hole mounting Mounting bracket, at device: Screw type Material: Metal
	429057	BT-2Z	Mounting bracket set	Design of mounting device: Angle, Z-shape Mounting bracket, at system: Through-hole mounting Mounting bracket, at device: Screw type Material: Metal





**Mounting technology - Swivel mounts**

	Part no.	Designation	Article	Description
	429393	BT-2HF	Mounting bracket set	Contains: 2x BT-HF swivel mount, 1 cylinder for mounting on the light curtain Mounting bracket, at system: Through-hole mounting Mounting bracket, at device: Clampable Type of mounting device: Turning, 360° Material: Metal, Plastic
	429394	BT-2HF-S	Mounting bracket set	Contains: 2x BT-HF swivel mount, 1 cylinder for mounting on the light curtain Mounting bracket, at system: Through-hole mounting Mounting bracket, at device: Clampable Type of mounting device: Turning, 360° Material: Metal, Plastic Shock absorber: Yes

**Mounting technology - Other**

	Part no.	Designation	Article	Description
	425740	BT-10NC60	Sliding block set	Contains: 10x BT-NC sliding block Bore hole 1: Ø 4.7 mm Bore hole 2: M6 Design of mounting device: Sliding block Mounting bracket, at system: Mounting thread Mounting bracket, at device: Groove mounting Material: Metal



**Part no.: 68002924 – MLC520R90-2400 – Safety light curtain receiver**

	Part no.	Designation	Article	Description
	425741	BT-10NC64	Sliding block set	Contains: 10x BT-NC-M4-M6 sliding block Bore hole 1: M4 Bore hole 2: M6 Design of mounting device: Sliding block Mounting bracket, at system: Mounting thread Mounting bracket, at device: Groove mounting Material: Metal
	425742	BT-10NC65	Sliding block set	Contains: 10x BT-NC-M5-M6 sliding block Bore hole 1: M5 Bore hole 2: M6 Design of mounting device: Sliding block Mounting bracket, at system: Mounting thread Mounting bracket, at device: Groove mounting Material: Metal
	424417	BT-2P40	Mounting bracket set	Contains: 2x BT-P40 clamp bracket Design of mounting device: Mounting clamp Mounting bracket, at system: Groove mounting Mounting bracket, at device: Groove mounting Type of mounting device: Clampable Material: Metal
	424422	BT-2SB10	Mounting bracket set	Contains: 2x BT-SB10 Design of mounting device: Mounting clamp Mounting bracket, at system: Through-hole mounting Mounting bracket, at device: Clampable, an der seitlichen C-Nut Type of mounting device: Swiveling Swivel range: -8 ... 8 ° Material: Metal
	424423	BT-2SB10-S	Mounting bracket set	Contains: 2x BT-SB10-S Design of mounting device: Mounting clamp Mounting bracket, at system: Through-hole mounting Mounting bracket, at device: Clampable, an der seitlichen C-Nut Swivel range: -8 ... 8 ° Material: Metal Shock absorber: Yes

**Display/operating elements**

	Part no.	Designation	Article	Description
	426296	AC-ABF70	Acknowledgment unit	Switching current via button: 1 ... 1,000 mA Housing material: Glass fiber reinforced (PPS), self-extinguishing Clamping plate material: Stainless steel Degree of protection: IP 67, IP 69K Functions: Reset of the start/restart interlock, Overriding with AOPDs with muting function, Illuminated reset buttons Reset buttons: Yes LED indicators: Yes



**Alignment aids**

	Part no.	Designation	Article	Description
	427300	AC-ALM	Alignment aid	Housing material: Plastic
	520101	AC-ALM-M	Alignment aid	Housing material: Plastic
	560020	LA-78U	Alignment aid	Light source: laser, Red Housing material: Metal

Part no.: 68002924 – MLC520R90-2400 – Safety light curtain receiver

	Part no.	Designation	Article	Description
	520004	LA-78UDC	Alignment aid	Light source: laser, Red Housing material: Metal

## Device columns

	Part no.	Designation	Article	Description
	549857	UDC-2500-S2	Device column	Dimensions: 160 mm x 2,560 mm x 149 mm Column height without foot: 2,500 mm Functions: Adjustable, 3 directions, Mounting and protection of light curtains and multiple light beam devices
	549865	UDC-3100-S2	Device column	Dimensions: 160 mm x 3,160 mm x 149 mm Column height without foot: 3,100 mm Functions: Mounting and protection of light curtains and multiple light beam devices, Adjustable, 3 directions

## Notes

Observe intended use!
<ul style="list-style-type: none"> <li>The product may only be put into operation by competent persons.</li> <li>Only use the product in accordance with its intended use.</li> </ul>